



# WESTCODE SEMICONDUCTORS

Technical Publication  
**TN350C**

Issue 2  
June 1985

## Convertor Grade Capsule Thyristor Type N350C

820 amperes average: up to 1800 volts  $V_{RRM}$

### Ratings (Maximum values at 125°C Tj unless stated otherwise)

RATING	CONDITIONS	SYMBOL	
Average on-state current	Half sine wave $\left\{ \begin{array}{l} 55^\circ\text{C heatsink temperature} \\ \text{(double side cooled)} \\ 85^\circ\text{C heatsink temperature} \\ \text{(single side cooled)} \end{array} \right.$	$I_{T(AV)}$	820A 320A
R.M.S. on-state current	25°C heatsink temperature, double side cooled	$I_{T(RMS)}$	1640A
Continuous on-state current	25°C heatsink temperature, double side cooled	$I_T$	1400A
Peak one-cycle surge (non-repetitive) on state current	10ms duration, 60% $V_{RRM}$ re-applied	$I_{TSM(1)}$	11500A
	10ms duration, $V_R \leq 10$ volts	$I_{TSM(2)}$	12650A
Maximum permissible surge energy	10ms duration, $V_R \leq 10$ volts	$I^2t(2)$	800000A <sup>2</sup> s
	3ms duration, $V_R \leq 10$ volts	$I^2t$	590000A <sup>2</sup> s
Peak forward gate current	Anode positive with respect to cathode	$I_{FGM}$	20A
Peak forward gate voltage	Anode positive with respect to cathode	$V_{FGM}$	22V
Peak reverse gate voltage		$V_{RGM}$	5V
Average gate power		$P_G$	4W
Peak gate power	100µs. pulse width	$P_{GM}$	120W
Rate of rise of off-state voltage	To 80% $V_{DRM}$ gate open-circuit	$dv/dt$	* 200V/µs
Rate of rise of on-state current (repetitive)	$\left\{ \begin{array}{l} \text{Gate drive 20 volts, 20 ohms with } t_r \leq 1\mu\text{s.} \\ \text{Anode voltage } \leq 80\% V_{DRM} \end{array} \right.$	$di/dt(1)$	500A/µs
Rate of rise of on-state current (non-repetitive)		$di/dt(2)$	1000A/µs
Operating temperature range		$T_{hs}$	- 40 + 125°C
Storage temperature range		$T_{stg}$	- 40 + 150°C

### Characteristics (Maximum values at 125°C Tj unless stated otherwise)

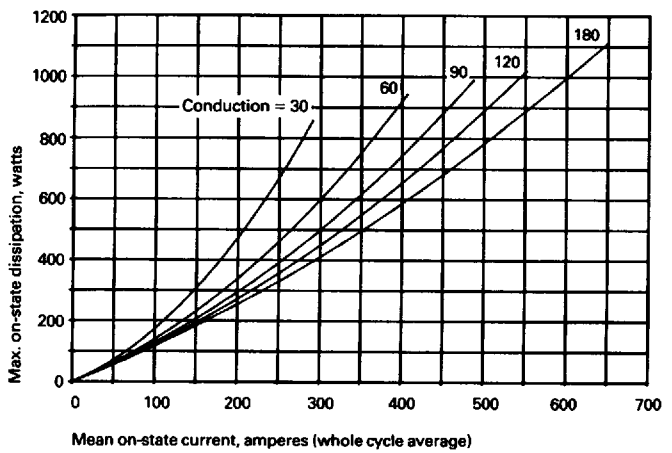
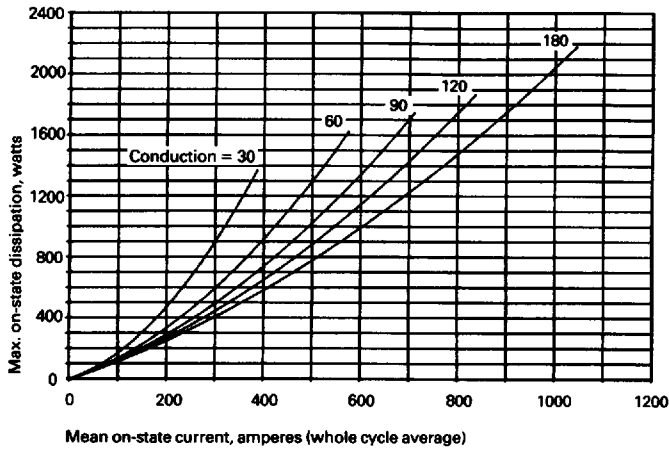
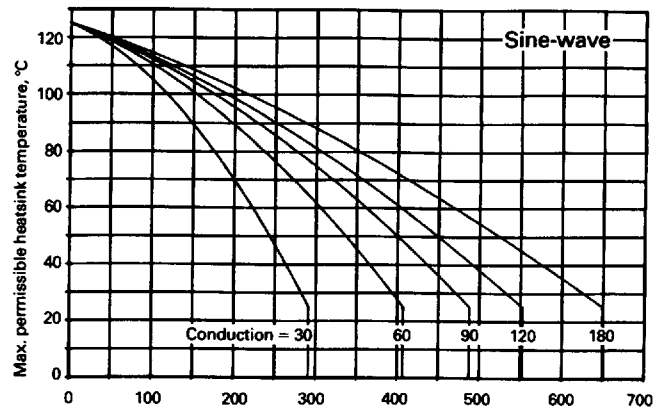
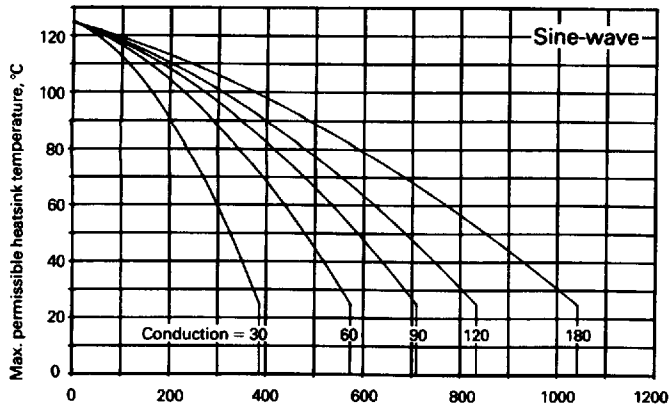
CHARACTERISTIC	CONDITIONS	SYMBOL	
Peak on-state voltage	At 1700 A, $I_{TM}$	$V_{TM}$	1.75V
Forward conduction threshold voltage		$V_O$	1.08V
Forward conduction slope resistance		$r$	0.395Ω
Repetitive peak off-state current	At $V_{DRM}$	$I_{DRM}$	60mA
Repetitive peak reverse current	At $V_{RRM}$	$I_{RRM}$	60mA
Maximum gate current required to fire all devices	$\left\{ \begin{array}{l} V_A = 6 \text{ V, } I_A = 2 \text{ A at } 25^\circ\text{C Tj} \end{array} \right.$	$I_{GT}$	300mA
Maximum gate voltage required to fire all devices		$V_{GT}$	3V
Maximum holding current		$I_H$	1A
Maximum gate voltage which will not trigger any device		$V_{GD}$	0.25V
Thermal resistance, junction to heatsink, for a device with a maximum forward volt drop characteristic	Double side cooled	$R_{th(j-hs)}$	0.044°C/W
	Single side cooled		0.088°C/W

VOLTAGE CODE		H02	H04	H06	H08	H10	H12	H14	H16	H18
Repetitive peak voltages	$V_{RRM}$ $V_{DRM}$	200	400	600	800	1000	1200	1400	1600	1800
Non-repetitive peak off-state voltage	$V_{DSM}$									
Non-repetitive peak reverse blocking voltage	$V_{RSM}$	300	500	700	900	1100	1300	1500	1700	1900

### Ordering Information (Please quote device code as explained below – 8 digits)

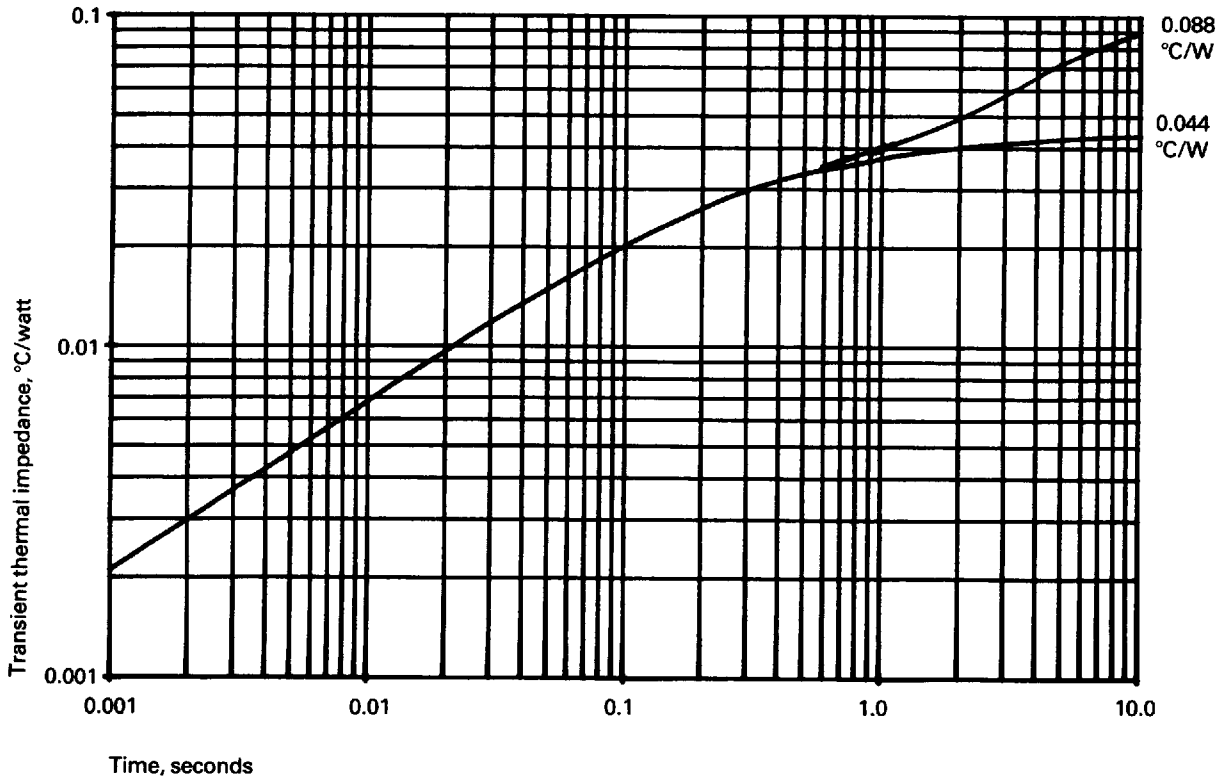
<b>N 3 5 0 C</b>	● ● ●	Typical code: N350CH16 = 1600 $V_{RRM}$ 1600 $V_{DRM}$ , 200 V/µs. dv/dt to 80% $V_{DRM}$
	Voltage code (see ratings)	

\* Other values of dv/dt may be available.

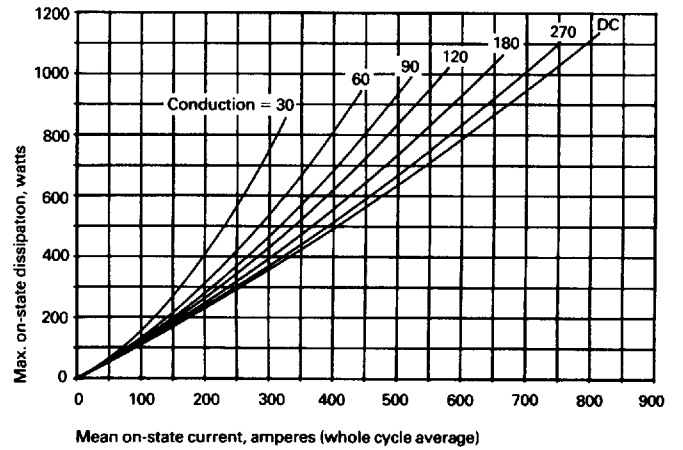
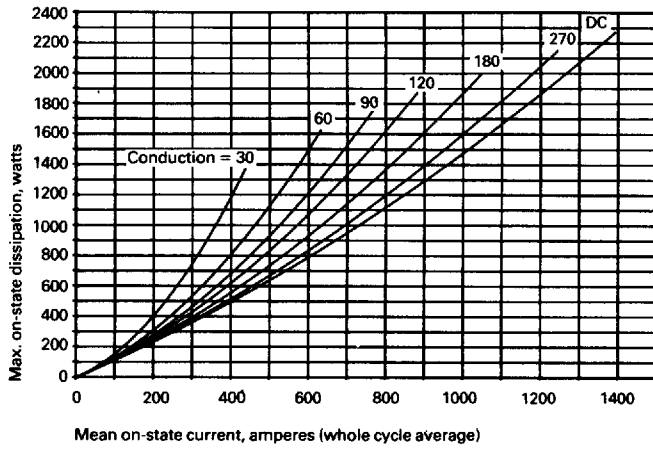
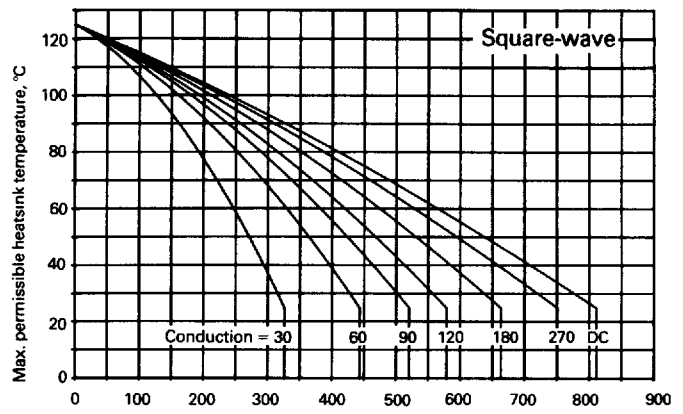
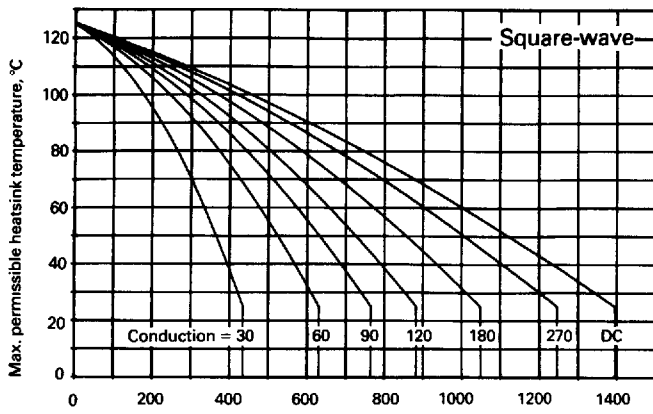


**Figure 1 Dissipation and heatsink temperature v. current (Double side cooled)**

**Figure 2 Dissipation and heatsink temperature v. current (Single side cooled)**

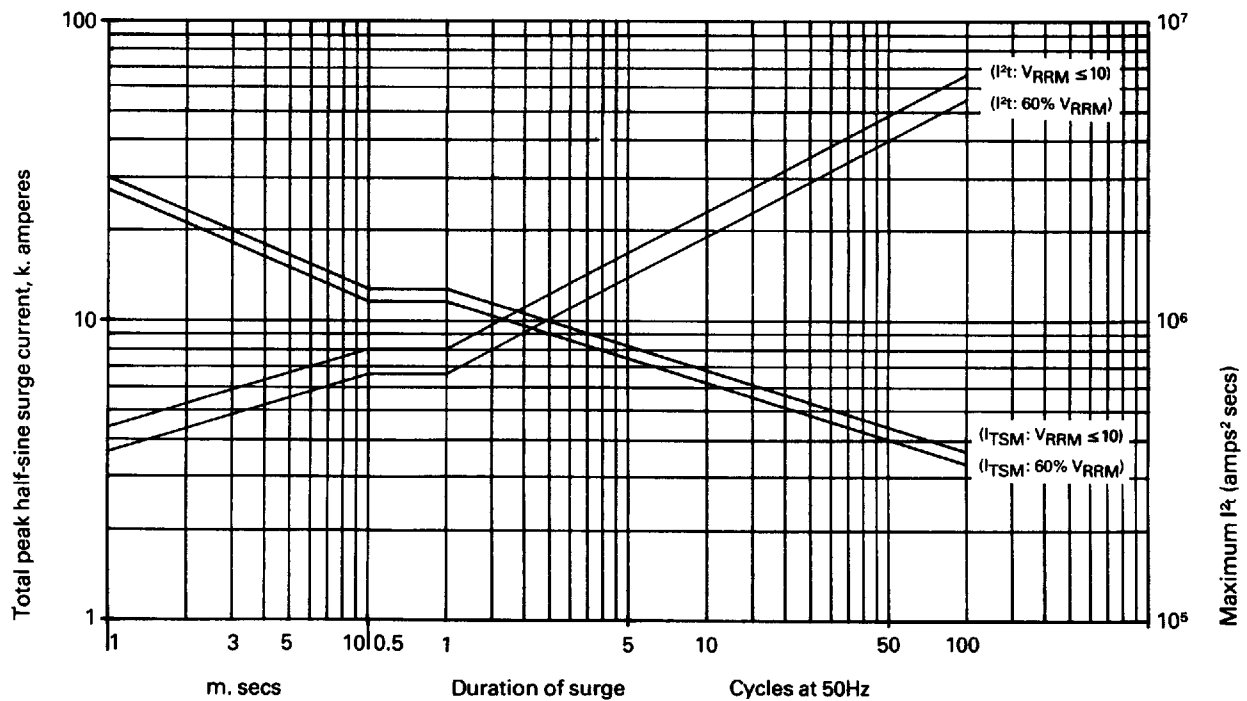


**Figure 3 Junction to heatsink thermal impedance**



**Figure 4 Dissipation and heatsink temperature v. current (Double side cooled)**

**Figure 5 Dissipation and heatsink temperature v. current (Single side cooled)**



**Figure 6 Max. non-repetitive surge current at initial junction temperature 125°C.**

(gate may temporarily lose control of firing angle)

Note: This rating must not be interpreted as an intermittent rating

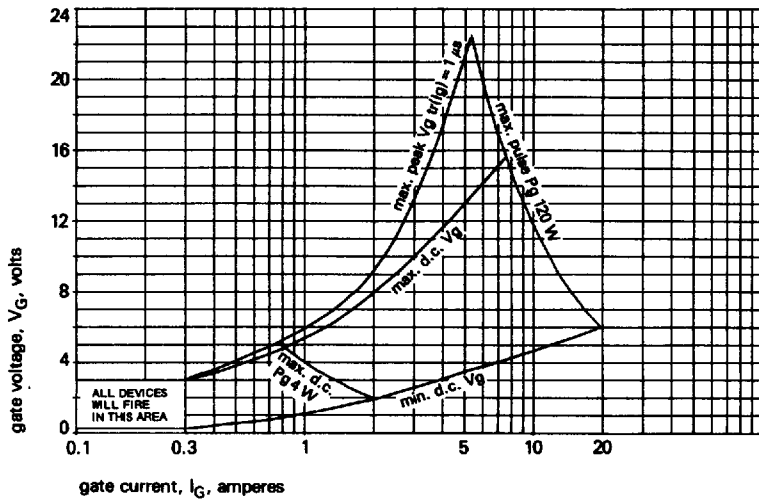


Figure 7 Gate characteristics at 25°C junction temperature

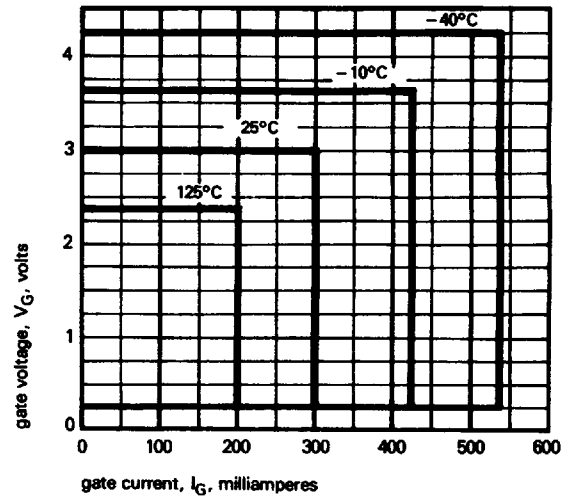


Figure 8 Gate triggering characteristics  
Trigger points of all thyristors lie within the areas shown

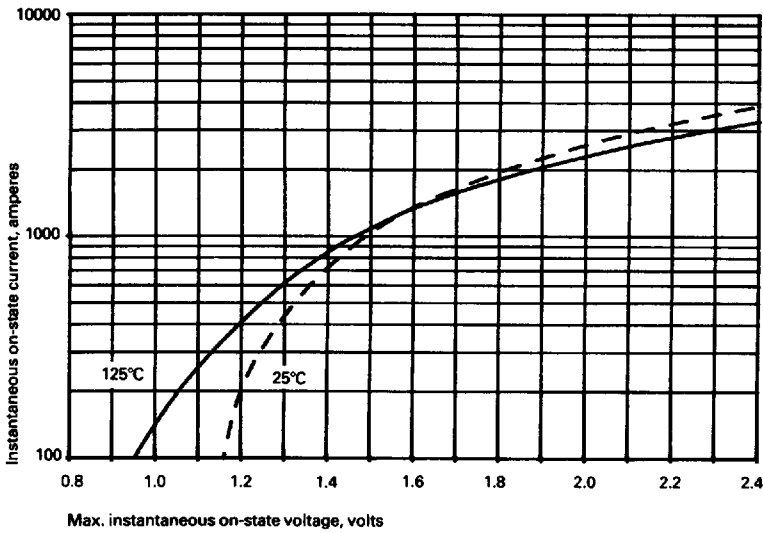
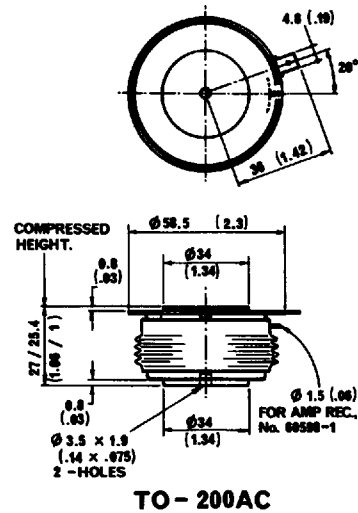


Figure 9 Limit on-state characteristic



TO-200AC  
Dimensions in mm (inches)  
Mounting force: 1000-2000 Kg  
Weight: 340 grams

In the interest of product improvement, Westcode reserves the right to change specifications at any time without notice.

**WESTCODE SEMICONDUCTORS LTD.**

P.O. Box 57 Chippenham Wiltshire SN15 1JL England  
Telephone Chippenham (0249) 654141 Telex 44751

HAWKER SIDDELEY

Westinghouse Brake and Signal Co. Ltd.

