

GCA200AA60

UL; E76102 (M)

SanRex IGBT Module GCA200AA60 is designed for Large current high speed switching. This module is insulated type, and contains two IGBTs in a series configuration and a fast recovery diode (trr=100ns) anti-parallelly connected to each IGBT.

- $I_c = 200A / V_{CES} = 600V / V_{ECS} = 1.6V$
- $V_{CE(SAT)} = 2.8V$ (Max)
- Soft recovery diode

(Applications)

Motor control (VVVF), UPS, AC servo, Switching power supply, welding machine etc.

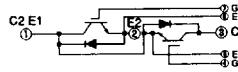
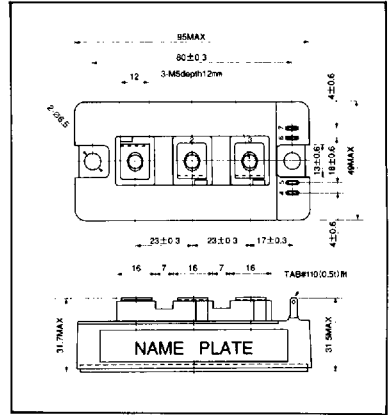

■ **Maximum Ratings**

(T_j = 25°C)

Symbol	Item		Conditions	Ratings		Unit
				GCA200AA60		
V _{CES}	Collector-Emitter Voltage			600		V
V _{GES}	Gate-Emitter Voltage			± 20		V
I _c	Collector Current	DC		200		A
I _{CP}		Pulse (1ms)		400		
-I _c	Reverse Collector Current			200		A
P _T	Total Power Dissipation		T _c = 25°C	780		W
T _j	Junction Temperature			150		°C
T _{stg}	Storage Temperature			-40 ~ +125		°C
V _{ISO}	Isolation Voltage (R.M.S)		A.C. 1minute	2500		V
	Mounting Torque	Mounting (M6)	Recommended Value 2.5~3.9 (25~40)	4.7 (48)		N·m (kgf·cm)
		Terminals (M5)	Recommended Value 1.5~2.5 (15~25)	2.7 (28)		
	Mass		Typical value	225		g

■ **Electrical Characteristics**

(T_j = 25°C)

Symbol	Item		Conditions	Ratings			Unit
				Min.	Typ.	Max.	
I _{GES}	Gate Leakage Current		V _{GE} = ± 20V, V _{CE} = 0V			± 500	nA
I _{CES}	Collector Cut-Off Current		V _{CE} = 600V, V _{GE} = 0V			2.0	mA
V _{(BR)CES}	Collector-Emitter Breakdown Voltage		V _{GE} = 0V, I _c = 1mA	600			V
V _{GE(th)}	Gate Threshold Voltage		V _{CE} = 5V, I _c = 20mA	3.0	2.0	7.0	V
V _{CE(sat)}	Collector-Emitter Saturation Voltage		I _c = 200A, V _{GE} = 15V		2.2	2.8	V
C _{ies}	Input Capacitance		V _{CE} = 25V, V _{GE} = 0V, f = 1MHz		15000	20000	pF
td(on)	Switching Time	Turn-on Delay Time	I _c = 200A, V _{GE} = +15V / -5V V _{CC} = 300V, R _G = 3Ω		0.20	0.40	μs
tr		Rise Time			0.10	0.20	
td(off)		Turn-off Delay Time			0.40	0.80	
tf		Fall Time			0.20	0.30	
V _{ECS}	Emitter-Collector Voltage		-I _c = 200A, V _{GE} = 0V		1.60		V
trr	Reverse Recovery Time		-I _c = 200A, V _{GE} = -10V, di/dt = 400A/μs		0.1	0.15	μs
R _{th(j-c)}	Thermal Resistance		Tr-Case			0.16	°C/W
			D-Case			0.40	

Output Characteristics (Typical)

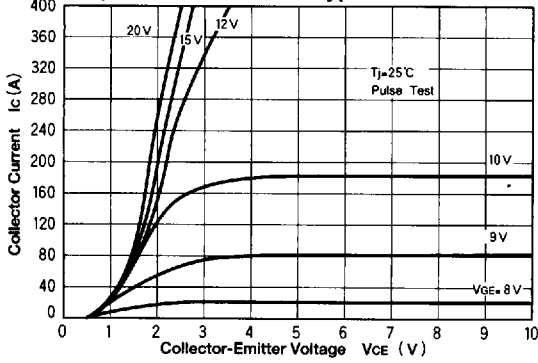

Forward Transfer Characteristics (Typical)

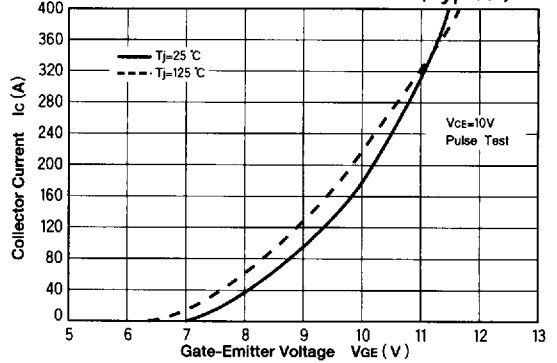

Saturation Voltage Characteristics (Typical)

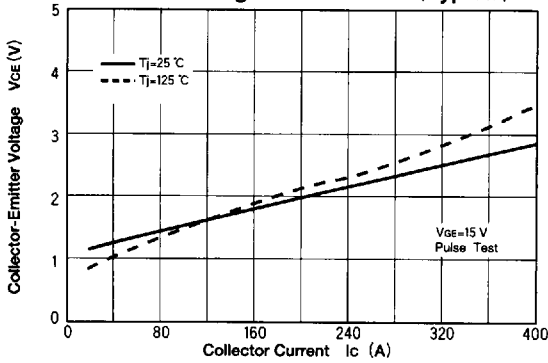

Collector-Emitter Saturation Voltage Characteristics (Typical)

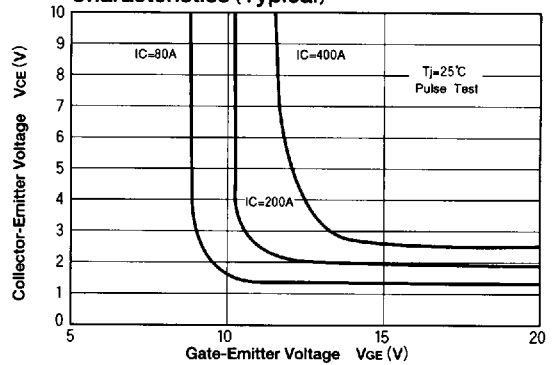

Forward Voltage of Free Wheeling Diode (Typical)

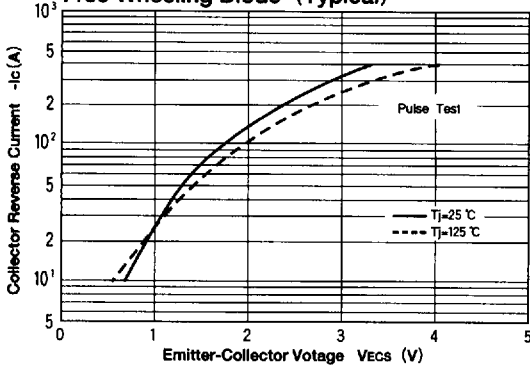

Input Capacitance, Output Capacitance, Transfer Capacitance (Typical)

